

# ELECTRIC RETRACTABLE LOCK MODEL ANA-60

Operating Conditions:  
 The complements (1) and (2) must be installed under the frontal of the electrical part of the lock, in order to adjust the spacing "E" between both frontals.

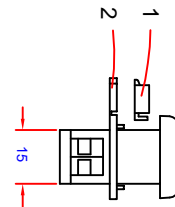

The separation between frontals "E" must be minimum, never above 3mm.

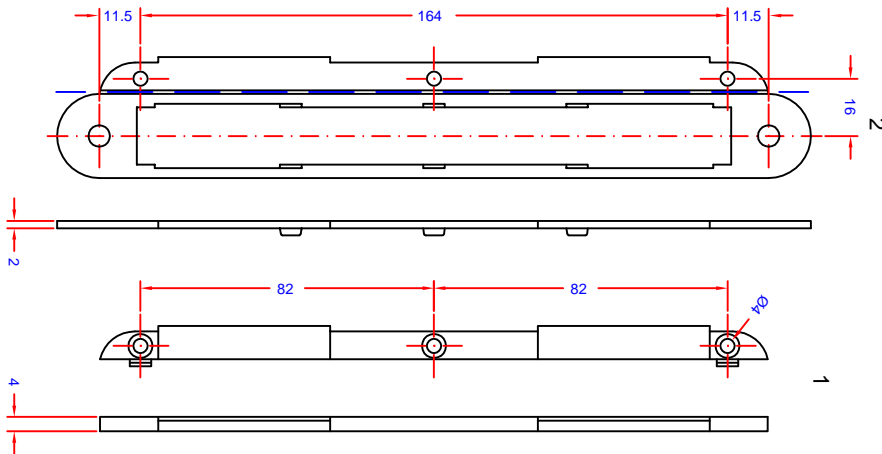
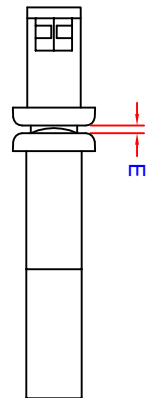

Removing the separator number 2 through the dot line, you will be able to supplement the locks frontal.

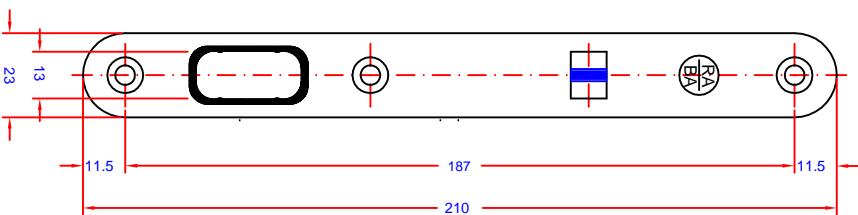
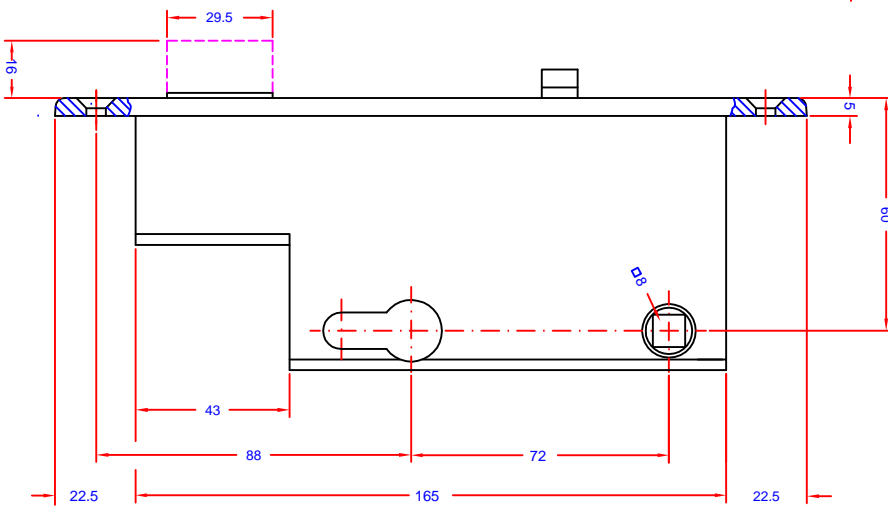
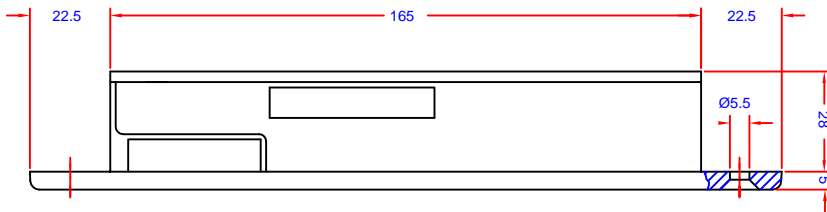
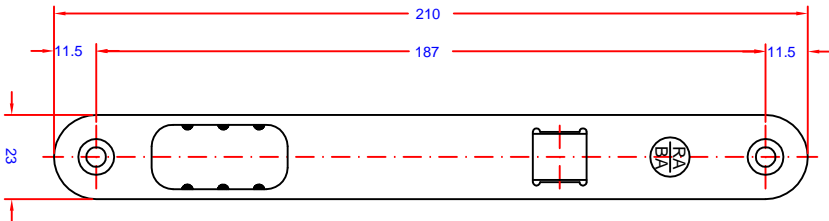
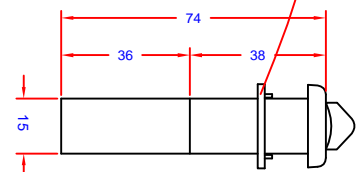

Feeding of: 12V - 15W